

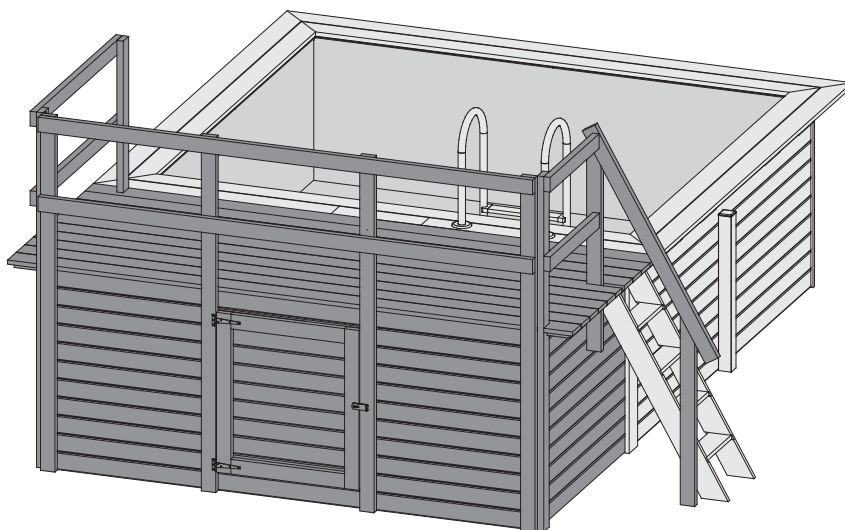









Poolterasse Front - für 45 mm Pools



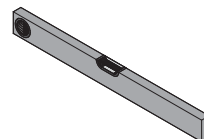
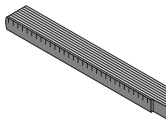
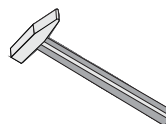
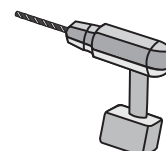
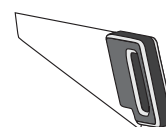

-  **Aufbauanleitung**
-  **Building Instructions**
-  **notice de montage**
-  **montagehandleiding**
-  **Montagevejledning**
-  **Instrucciones de construcción**
-  **Istruzioni per il montaggio**
-  **Montážní návod**





 Vergleichen Sie zuerst die Material-liste mit Ihrem Paketinhalt! Bitte haben Sie Verständnis, dass Beanstandungen nur im nicht aufgebauten Zustand bearbeitet werden können!

 Vergelijk eerst de lijst van materialen met de inhoud van uw pakket! Reclamaties kunnen alleen in behandeling worden genomen zolang de onderdelen nog niet zijn gemonteerd!

 Confrontate questa distinta materiali prima con il contenuto del pacchetto! Vi preghiamo di comprendere che eventuali reclami possono essere accolti solo prima del montaggio!

 First compare the list of materials with your package contents! Please understand that complaints can be processed in the non-built status only!

 Start med at kontrollere materialelisten med indholdet af den leverede pakke! Vi gør venligst opmærksom på at reklamationer kun kan behandles for materialer som ikke er blevet bearbejdet!

 Nejprve překontrolujte obsah balení podle materiálového listu! Mějte pochopení pro to, že případnou reklamaci se můžeme zabývat pouze tehdy, když díly nebudou smontované! Za pomoci tohoto seznamu můžete jednotlivé díly přiřadit k montážnímu návodu.

 Commencez par comparer la liste du matériel avec le contenu de votre paquet! Sachez que nous traitons uniquement les réclamations concernant le matériel à l'état non monté!

 En primer lugar, compare la lista de material con el contenido del paquete. Rogamos entienda que las reclamaciones sólo pueden ser tramitadas antes de montar el objeto!

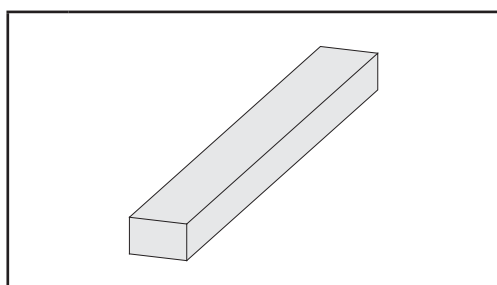
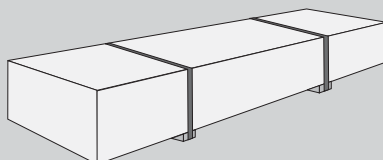

11 x B1	3308 x 140 x 26 mm	ID 25303
1 x B2	386 x 58 x 28 mm	ID 25881
6 x B3	322 x 90 x 40 mm	ID 25857
6 x B4	1222 x 90 x 40 mm	ID 25856
2 x B5	808 x 90 x 40 mm	ID 25299
2 x B6	1155 x 90 x 40 mm	ID 39906
9 x B7	1570 x 90 x 40 mm	ID 25296
7 x B8	2177 x 90 x 40 mm	ID 25297
2 x B9	2852 x 90 x 40 mm	ID 25298
2 x B10	3087 x 90 x 40 mm	ID 25300

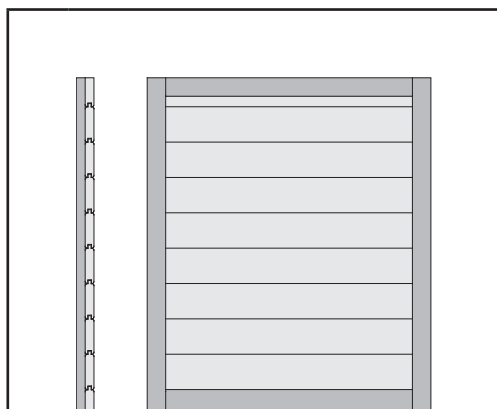

1 x D1	980 x 890 x 28 mm	ID 25834
--------	-------------------	----------

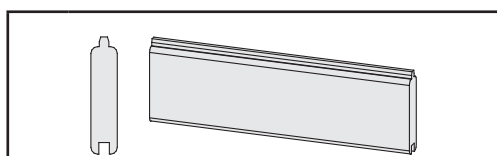

18 x W1	1066 x 121 x 28 mm	ID 25292
20 x W2	1490 x 121 x 28 mm	ID 25269
1 x W3	3032 x 121 x 28 mm	ID 25293

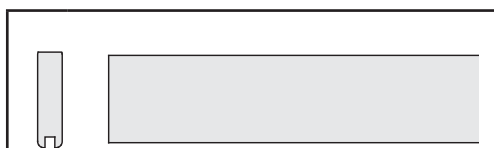

2 x W4	1490 x 102 x 28 mm	ID 25294
1 x W5	3032 x 102 x 28 mm	ID 25295

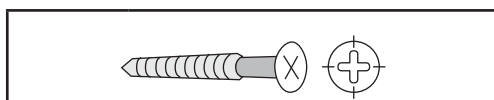

75 x	4 x 35 mm	ID 3687
20 x	4 x 30 mm	ID 61509
240 x	4 x 50 mm	ID 3688
70 x	4 x 70 mm	ID 3689
4 x	6 x 100 mm	ID 11749

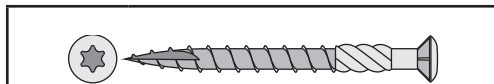

160 x	5 x 50 mm	ID 57137
-------	-----------	----------

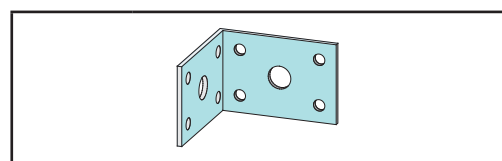

2 x	ID 21292
-----	----------

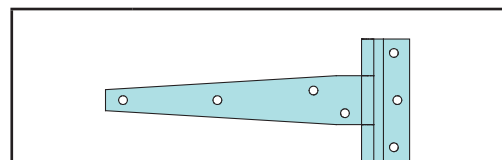

2 x	ID 3716
-----	---------

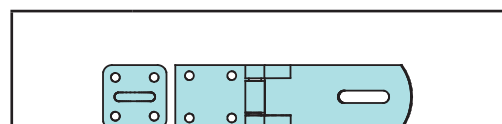

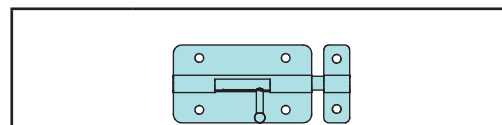

1 x	ID 3724
-----	---------





2 x	ID 3709
-----	---------

 Um das Ertrinken von Kindern zu verhindern, wird empfohlen, den Zugang zum Schwimmbecken mit einer Schutzeinrichtung zu sichern!

 For at forhindre drukning af børn anbefales det at sikre adgang til swimmingpoolen med en beskyttelsesanordning!

 To prevent the drowning of children, it is recommended to secure access to the swimming pool with a protective device!

 Para evitar que los niños se ahoguen, se recomienda asegurar el acceso a la piscina con un dispositivo de protección.





 Pour éviter la noyade des enfants, il est recommandé de sécuriser l'accès à la piscine avec un dispositif de protection!





 Per prevenire l'annegamento dei bambini, si consiglia di proteggere l'accesso alla piscina con un dispositivo di protezione!





 Om verdrinking van kinderen te voorkomen, is het aan te raden om de toegang tot het zwembad te beveiligen met een beschermend apparaat!

 Aby se zabránilo utopení dětí, doporučuje se zajistit přístup k bazénu s ochranným zařízením!





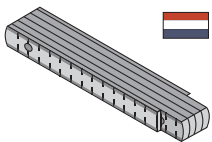

- *  Nicht im Lieferumfang enthalten
 Not included
 Non comprises dans la livraison
 Niet bijgeleverd

-  No forman parte del suministro
 Non incluso
 V ceně není zahrnuto
 Ikke inkluderet



- 1  Länge muss ermittelt und zugesägt werden
 Length must be determined and sawn
 La longueur doit être déterminée et sciée
 De lengte moet worden bepaald en worden gezaagd

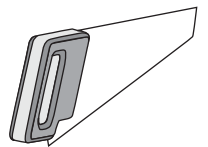

-  La longitud debe ser determinada y aserrada
 La lunghezza deve essere determinata e segata
 Délka musí být určena a rozřezána
 Længden skal bestemmes og savnes





- 2  Nicht gebraucht
 Not needed
 Pas nécessaire
 Niet nodig

-  No es necesario
 Non necessario
 Není nutná

 Vorbereitung
 preparation
 préparation

 voorbereiding
 forberedelse
 preparación

 preparazione
 příprava

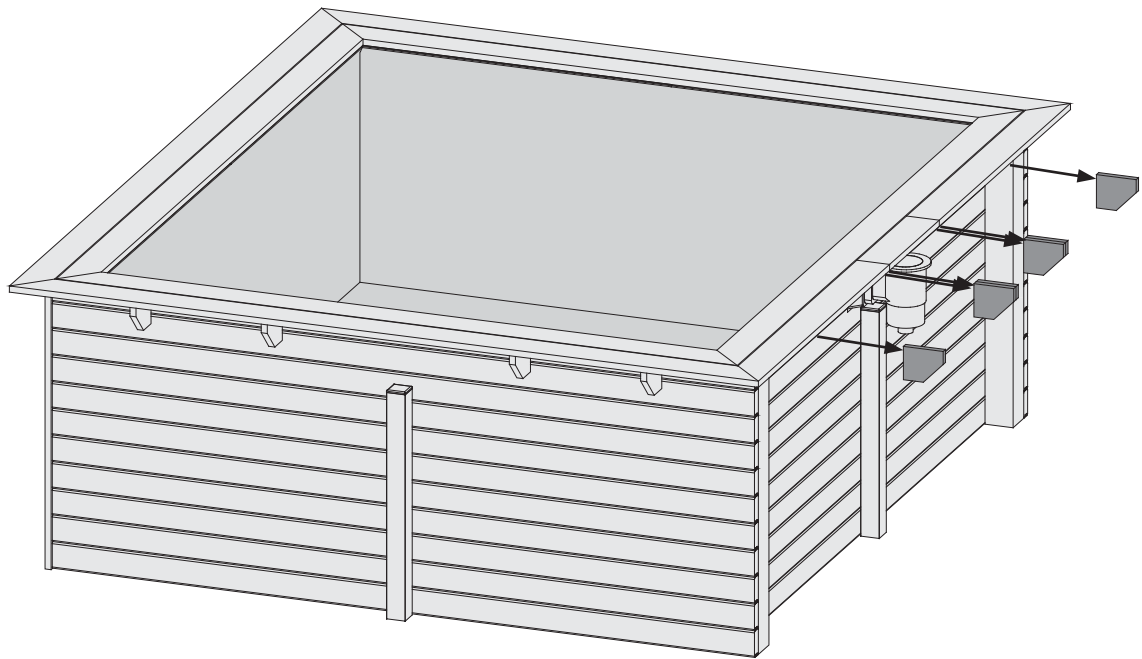
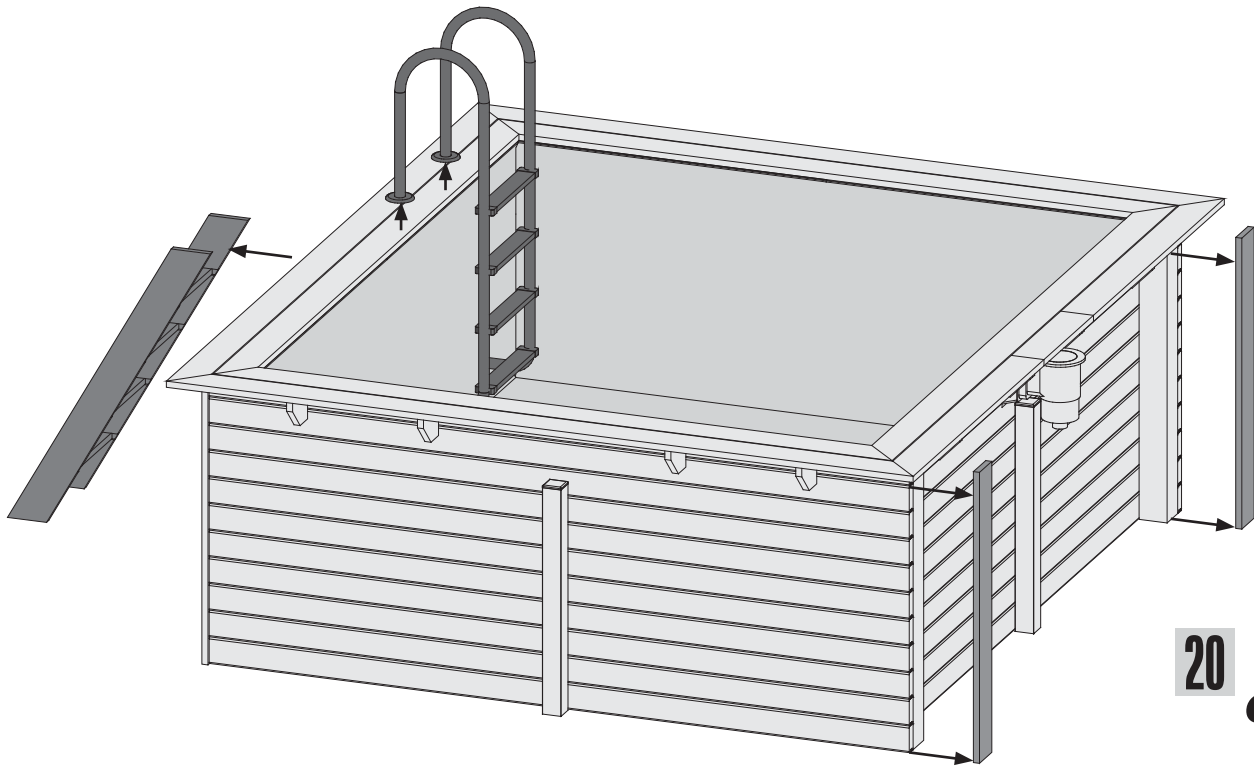

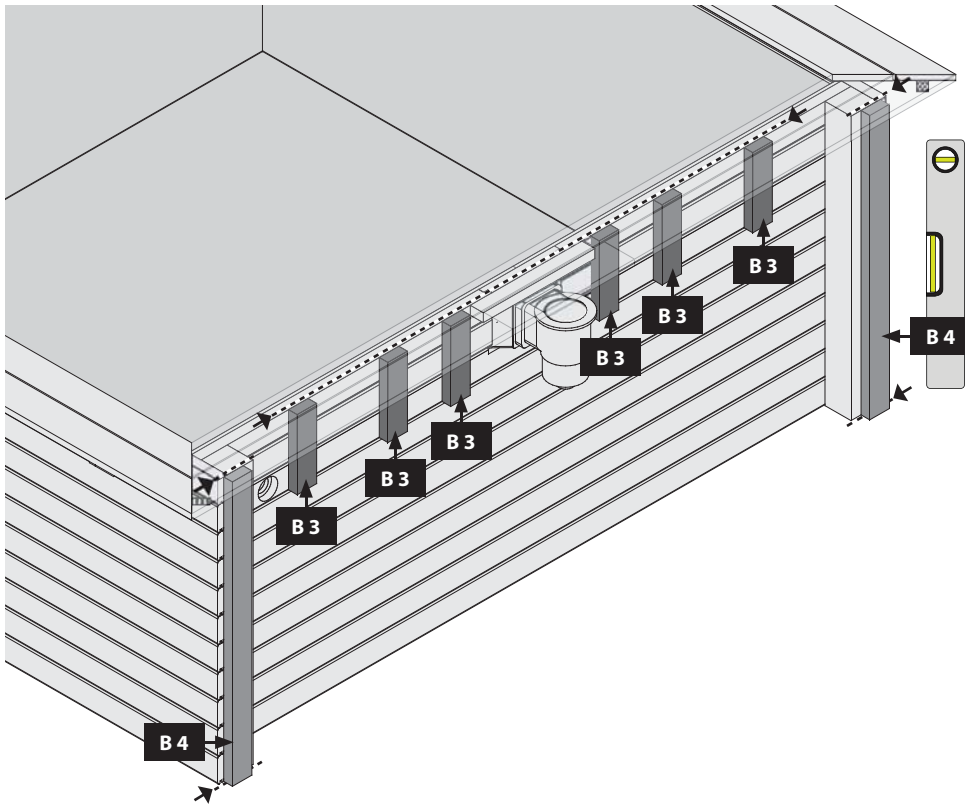

Ø3 mm 4x50

24x

Ø3 mm 4x70

16x

-  Bündig!
-  Flush!
-  Affleurement!
-  Gelijk!
-  I flugt!
-  Aras!
-  Combacia!
-  Stejný !

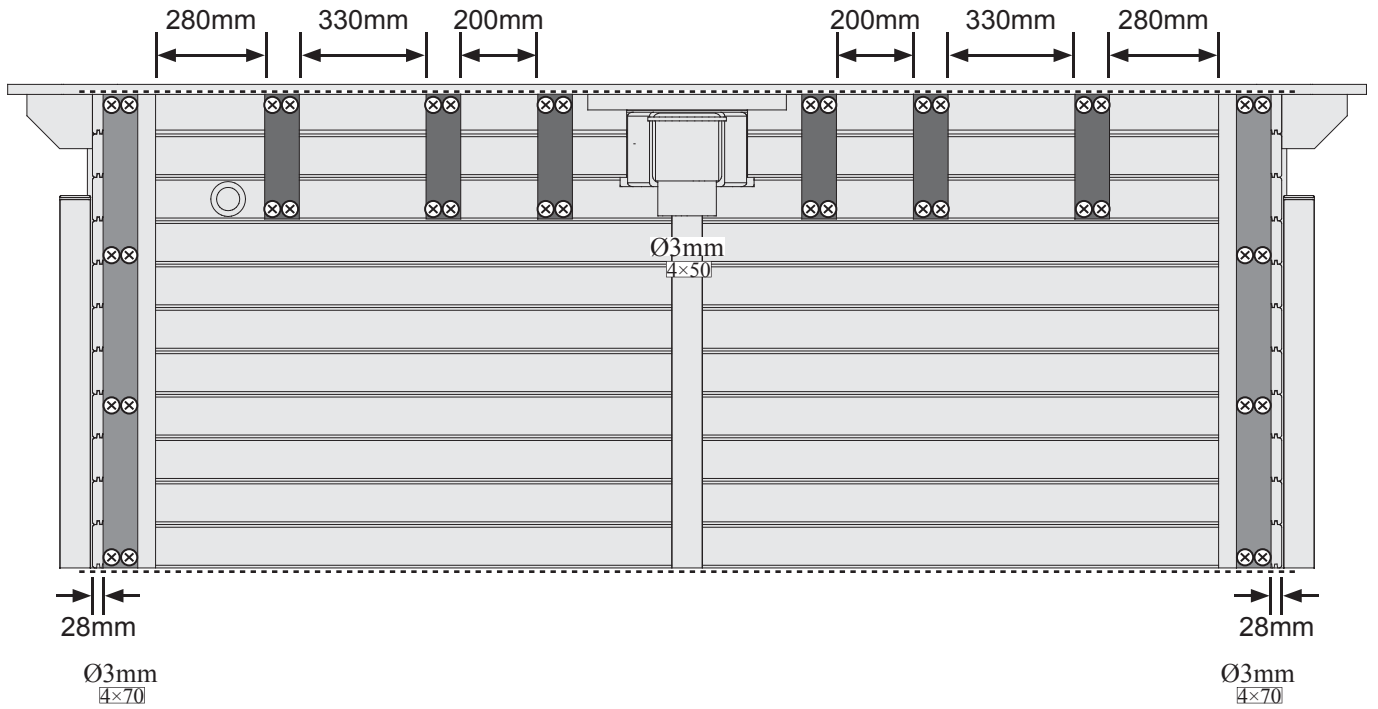

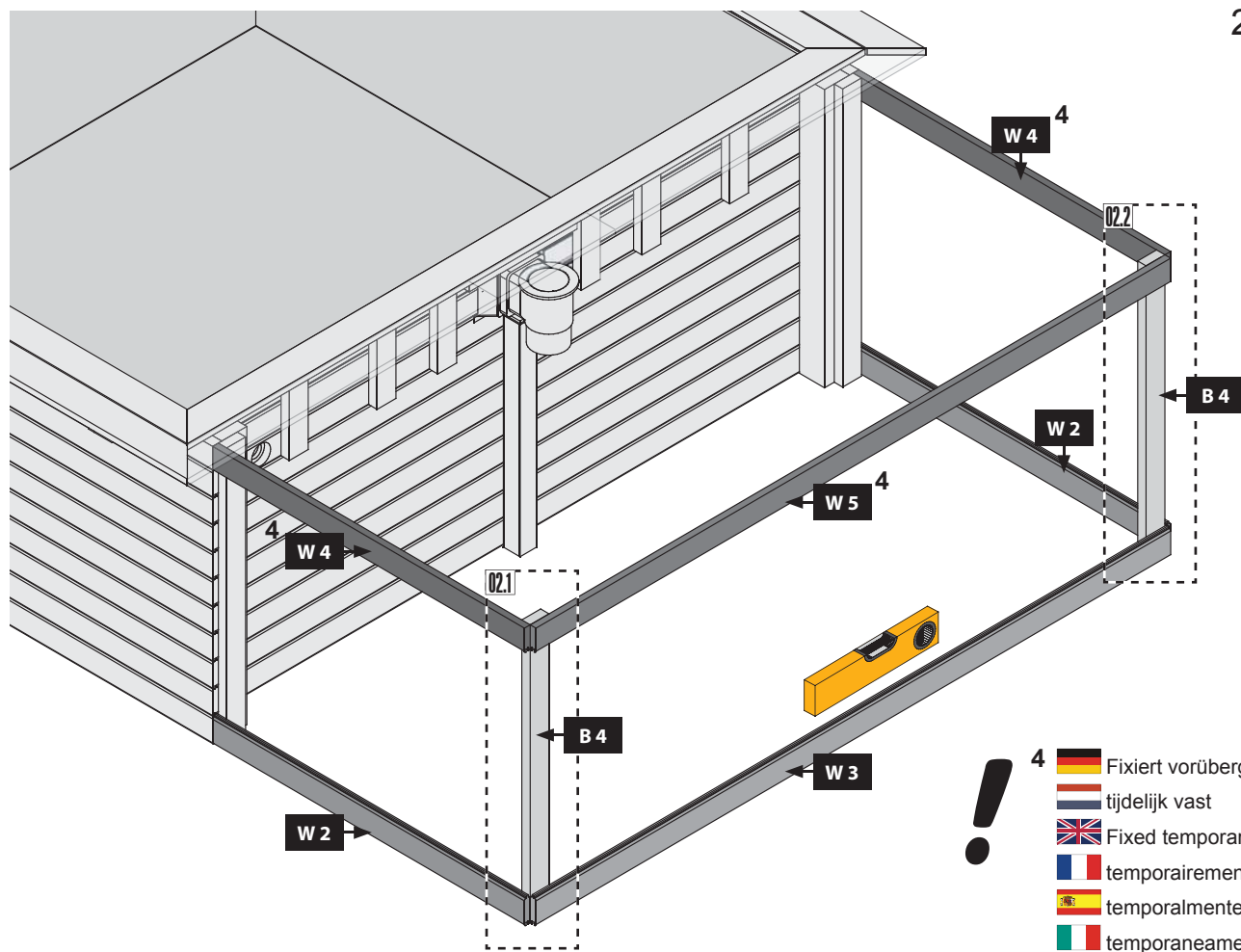
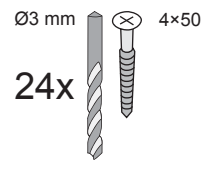

- ! 4
- Fixiert vorübergehend
 - tijdelijk vast
 - Fixed temporarily
 - temporairement fixe
 - temporalmente fijo
 - temporaneamente fisso
 - dočasně pevný
 - Začasno pritrjeno

02.1

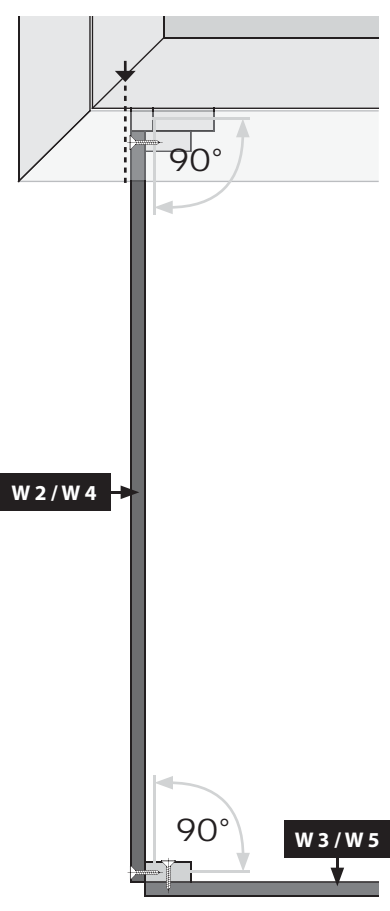





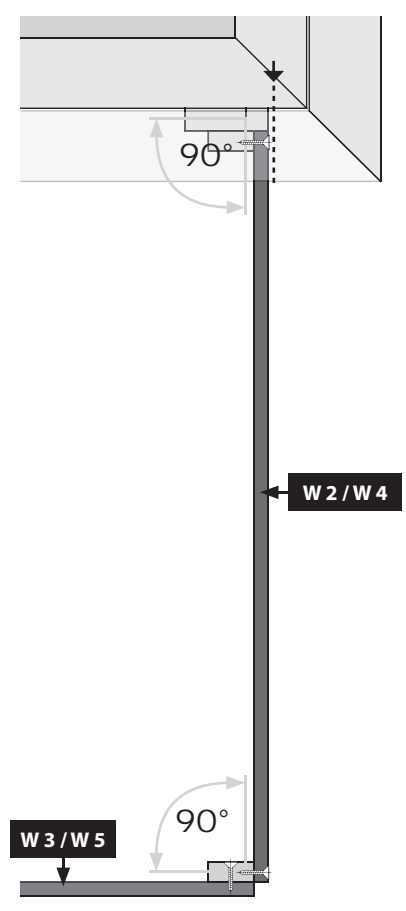

- Bündig!
- Flush!
- Affleurement!
- Gelijk!
- I flugt!
- Aras!
- Combacia!
- Stejný!



- Draufsicht
- Top view
- vue de dessus
- bovenaanzicht
- vista desde arriba
- vista desde arriba
- vista dall'alto
- půdorys

02.2



 Achten Sie auf die gleiche Höhe
 Look for the same height
 Faites attention à la même hauteur

 Besteed aandacht aan de dezelfde hoogte
 Prestar atención a la misma altura
 Prestare attenzione alla stessa altezza

 Dávejte pozor na stejnou výšku
 Pazite na enako višino

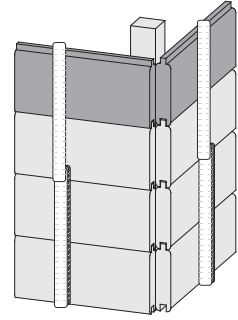
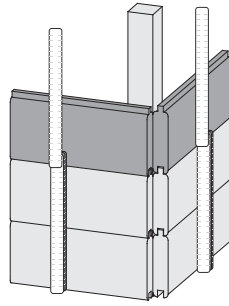
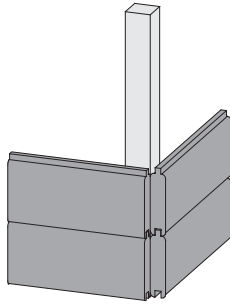
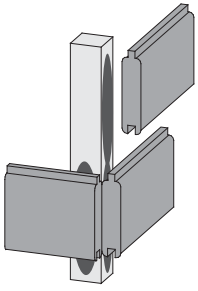

03

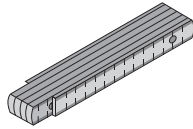

Ø3 mm  4x50

96x 

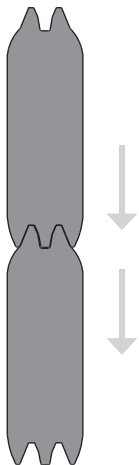
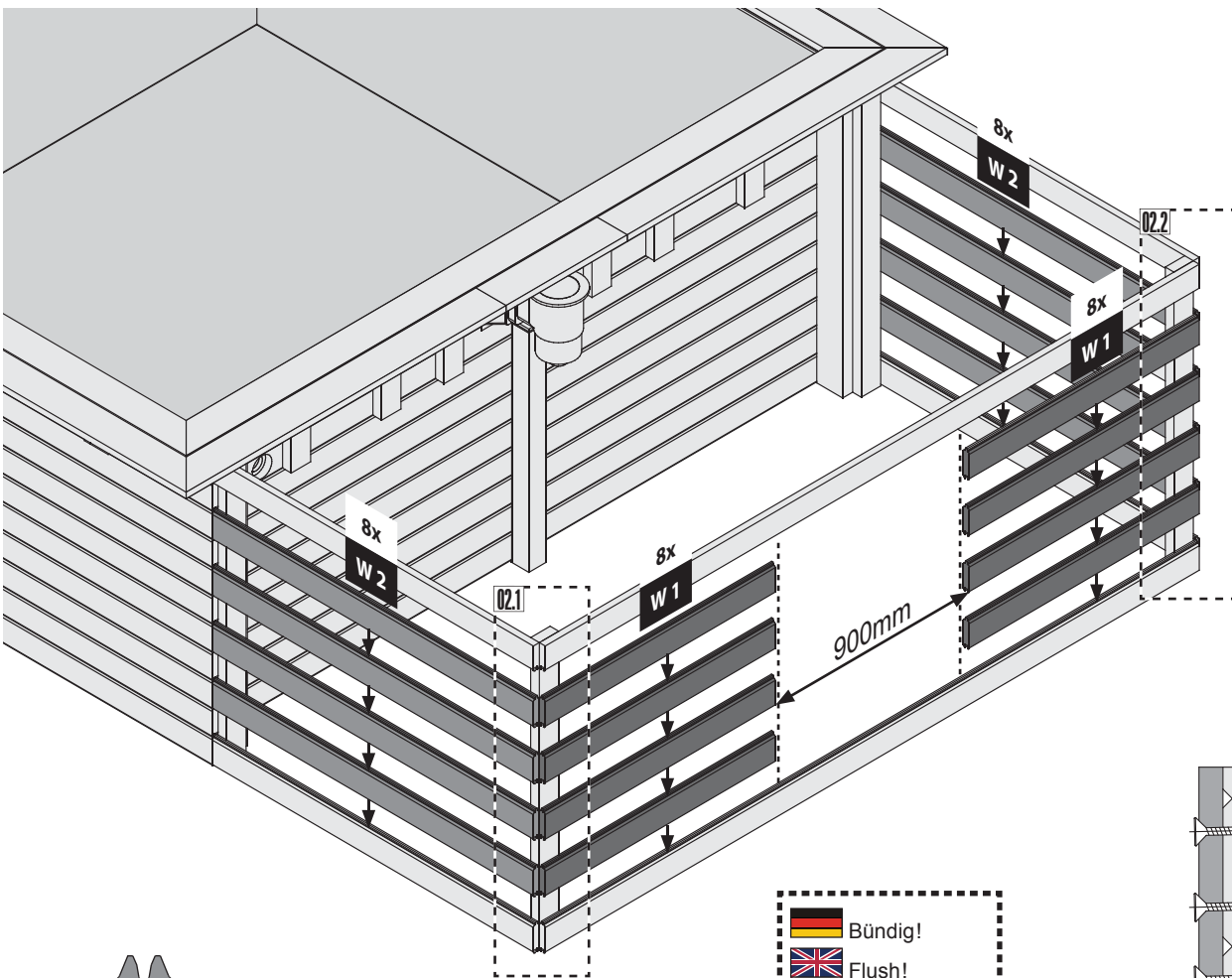

-  Bündig!
-  Flush!
-  Affleurement!
-  Gelijk!
-  I flugt!
-  Aras!
-  Combacia!
-  Stejný !

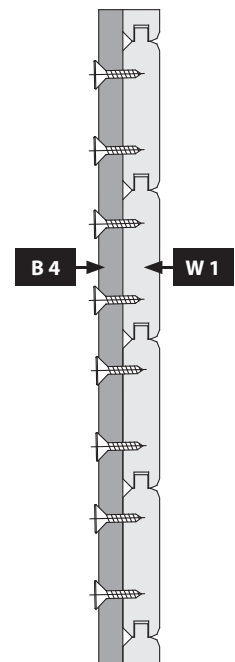

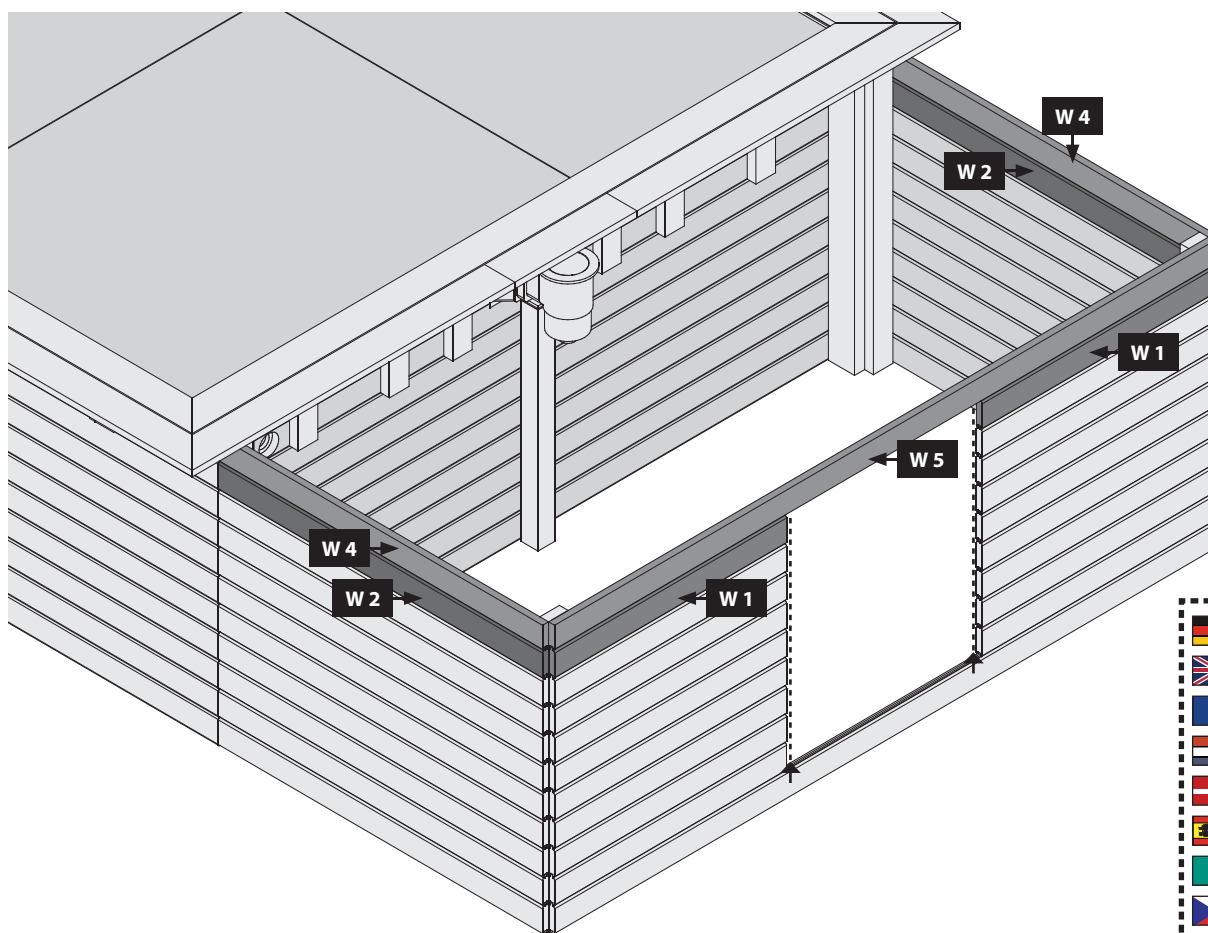
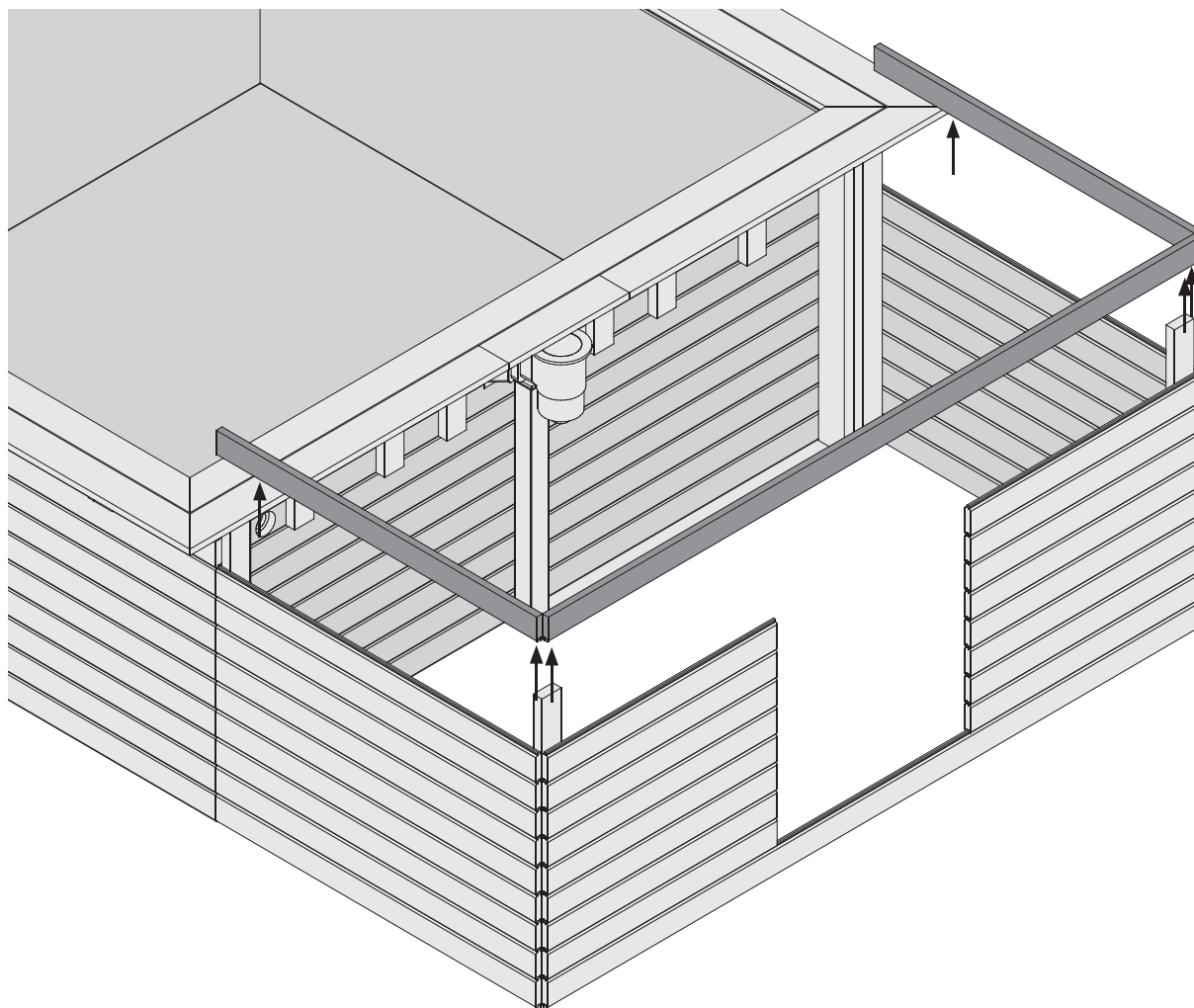

Ø3 mm 4x50

24x

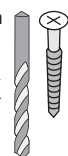

-  Bündig!
-  Flush!
-  Affleurement!
-  Gelijk!
-  I flugt!
-  Aras!
-  Combacia!
-  Stejný !

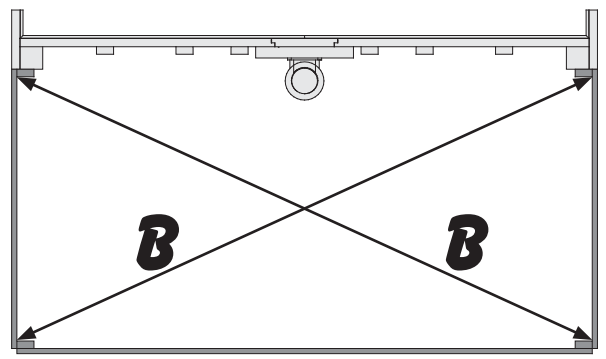
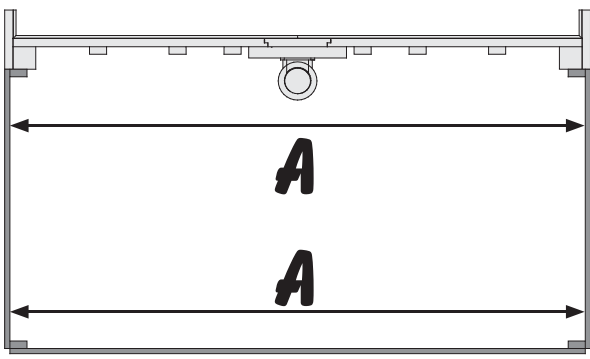

06

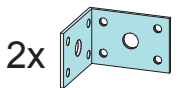
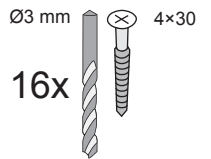
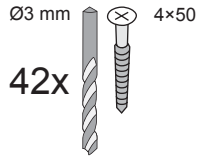
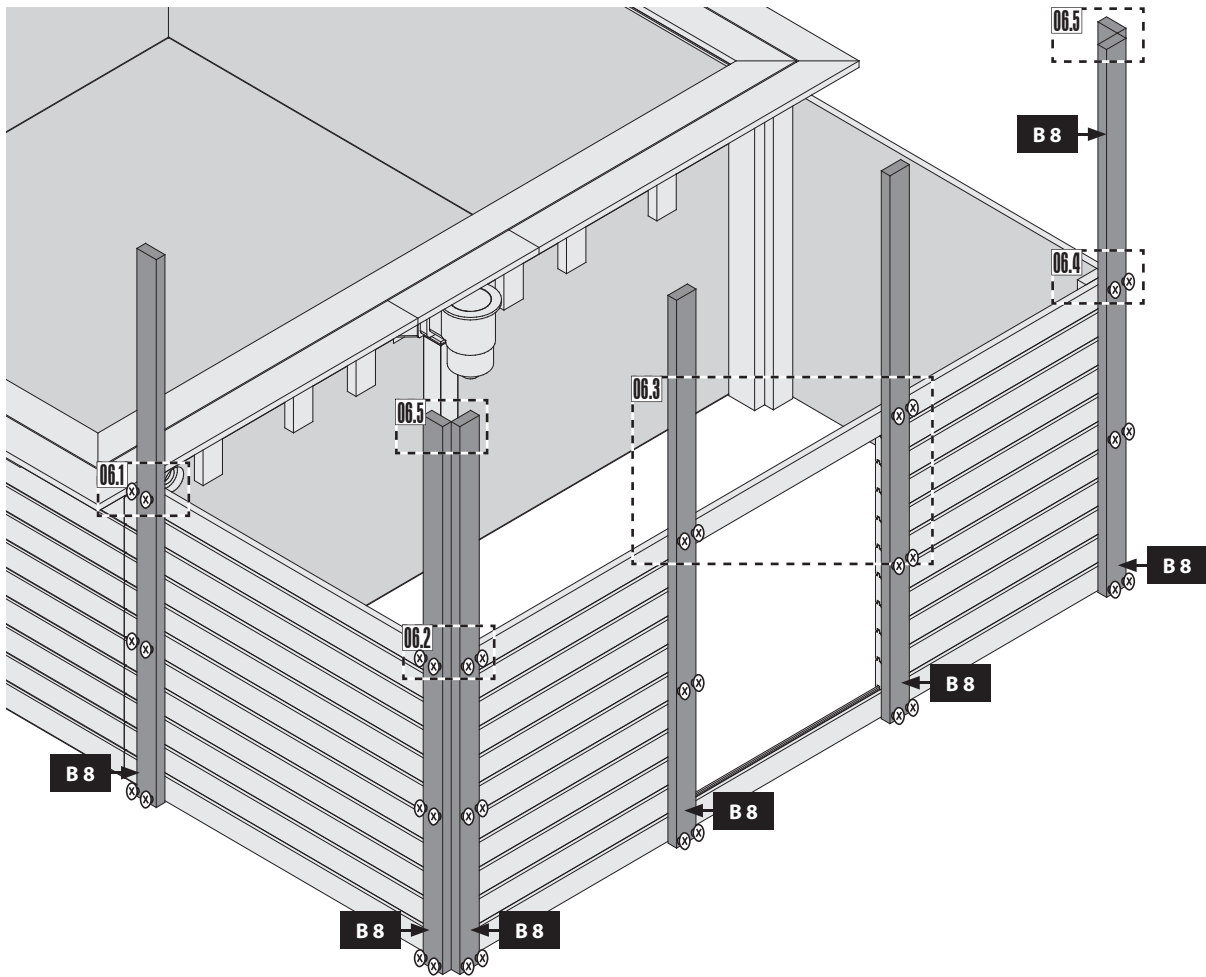

- Bündig!
- Flush!
- Affleurement!
- Gelijk!
- I flugt!
- Aras!
- Combacia!
- Stejný!

06.1

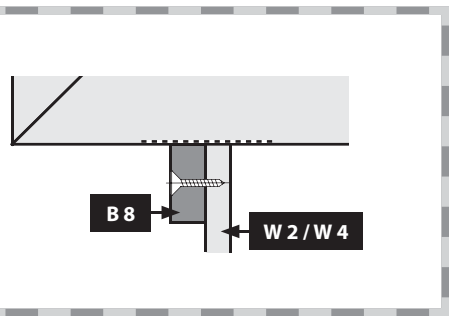

06.5

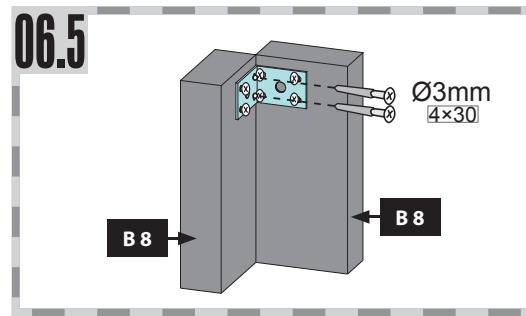

06.2

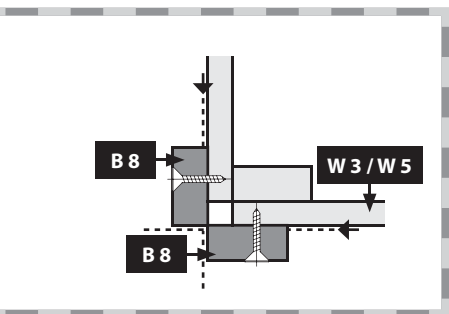

06.3

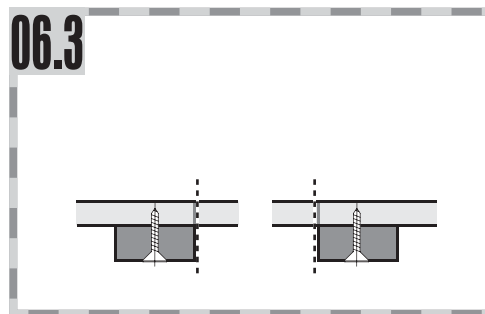

06.4

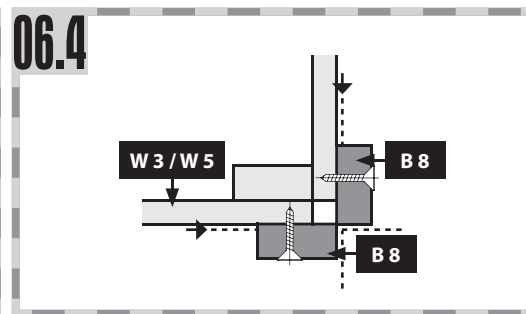

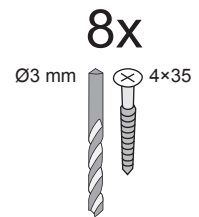
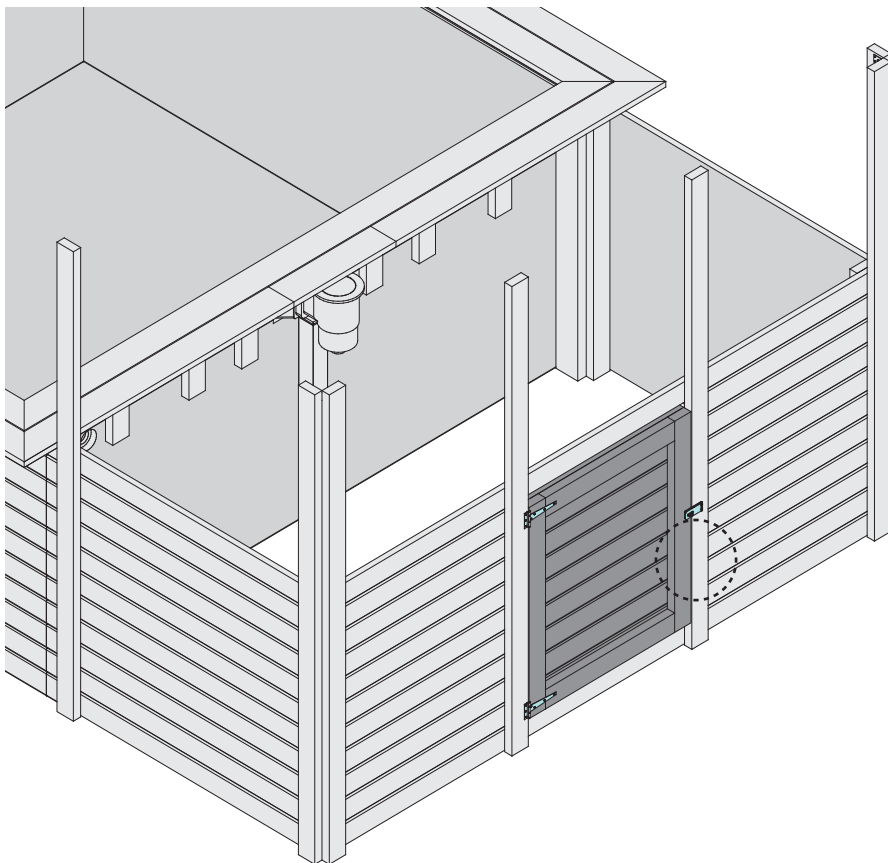
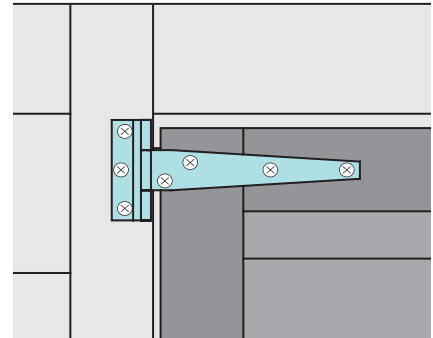
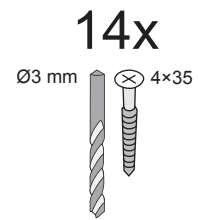
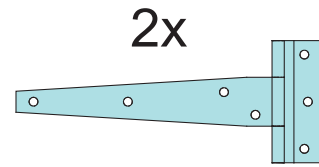
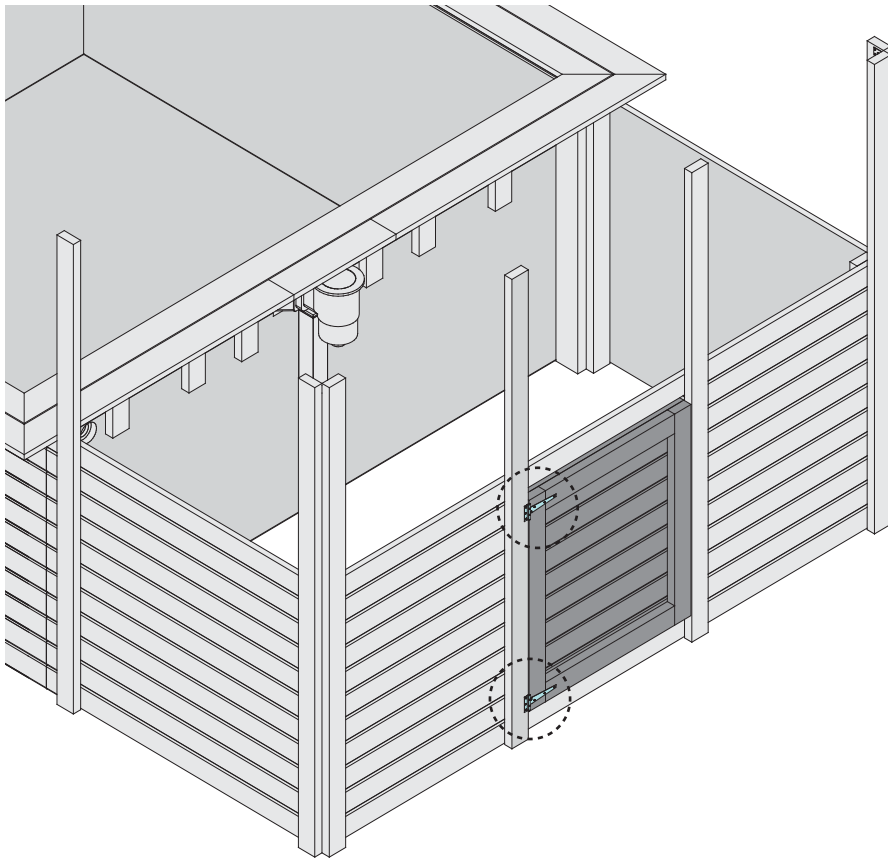

- | | |
|--|--|
|  Edelstahl |  rustfrit stål |
|  stainless steel |  acero inoxidable |
|  acier inoxydable |  acciaio inossidabile |
|  roestvrij staal |  nerez |

1.

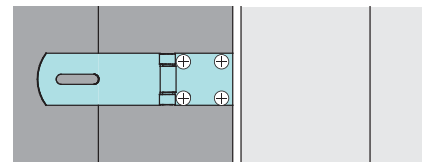

2.

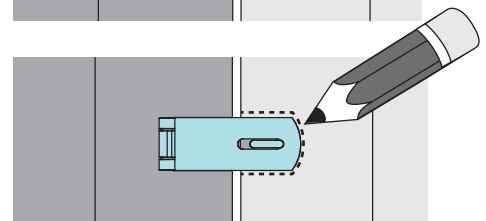

3.

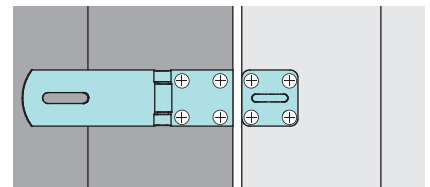

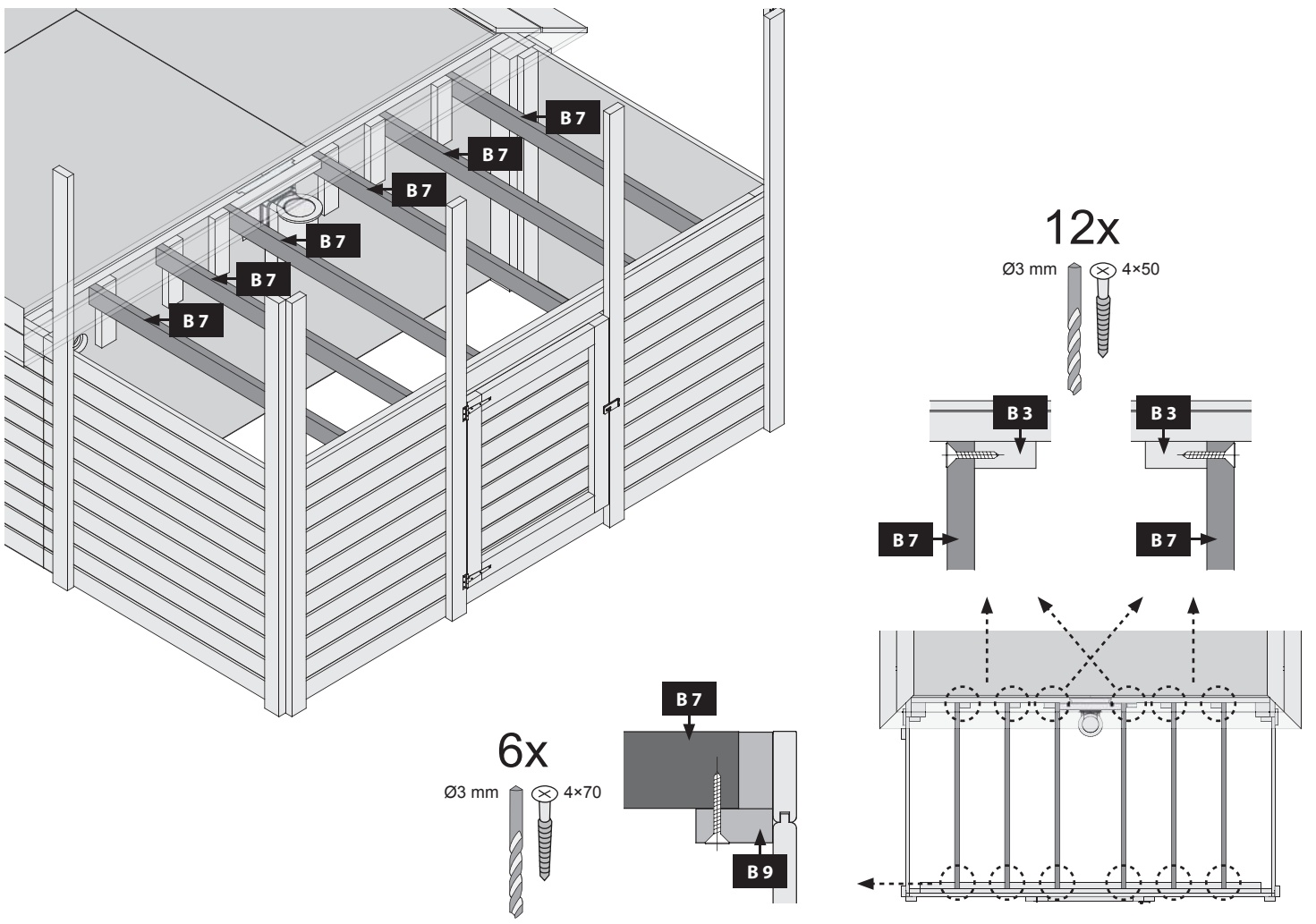
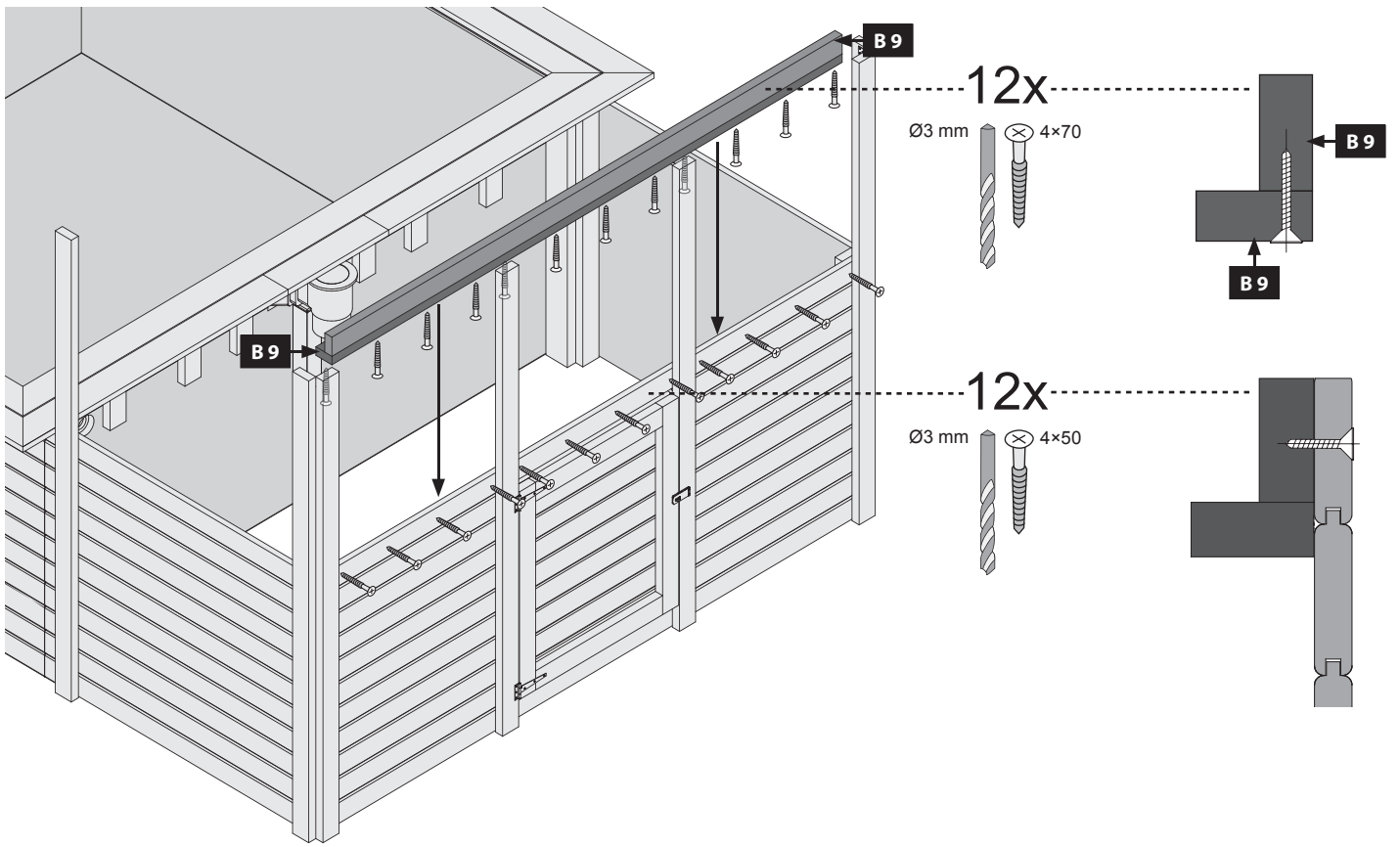

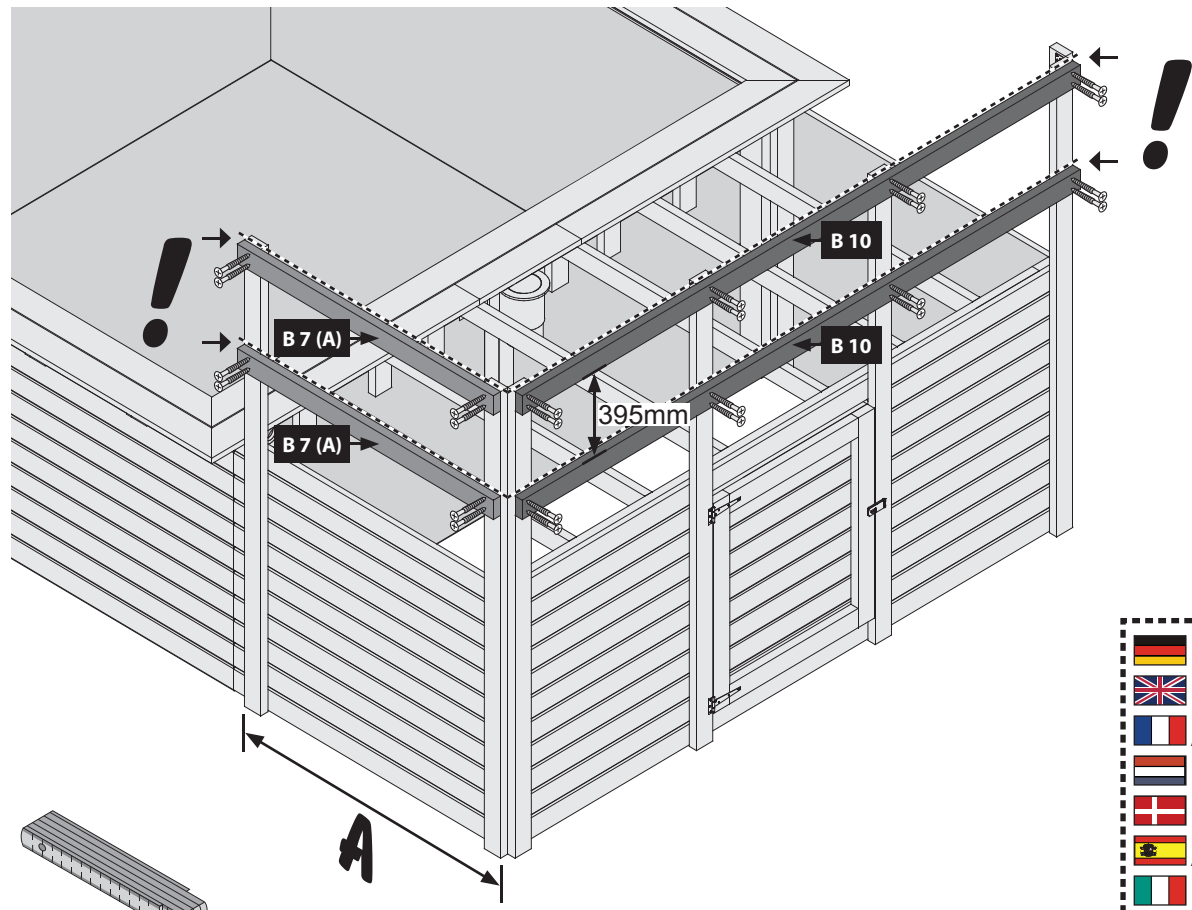

-  Bündig!
-  Flush!
-  Affleurement!
-  Gelijk!
-  I flugt!
-  Aras! ←
-  Combacia!
-  Stejný!

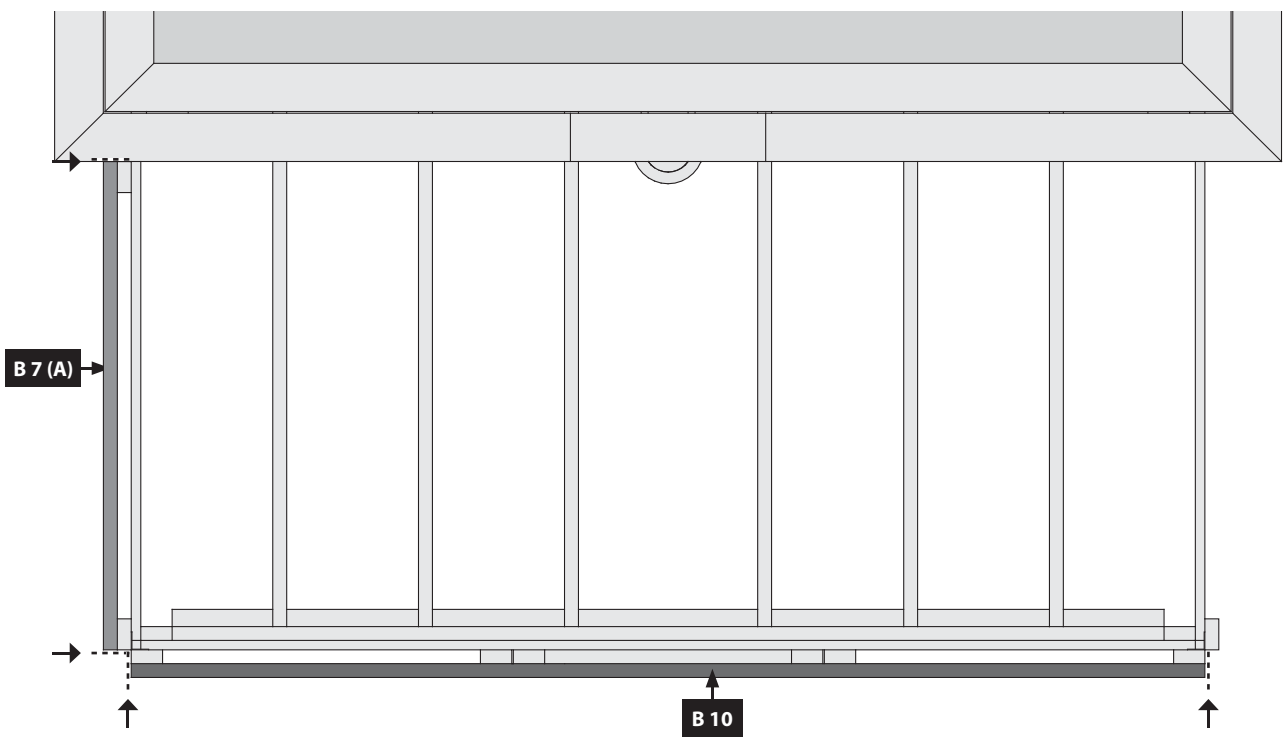
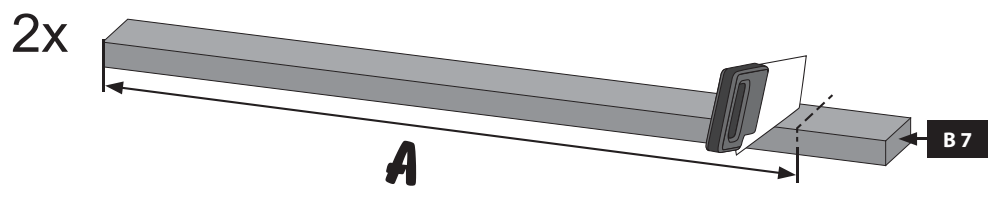

160x

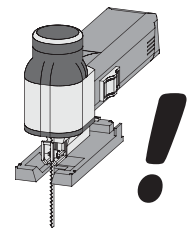
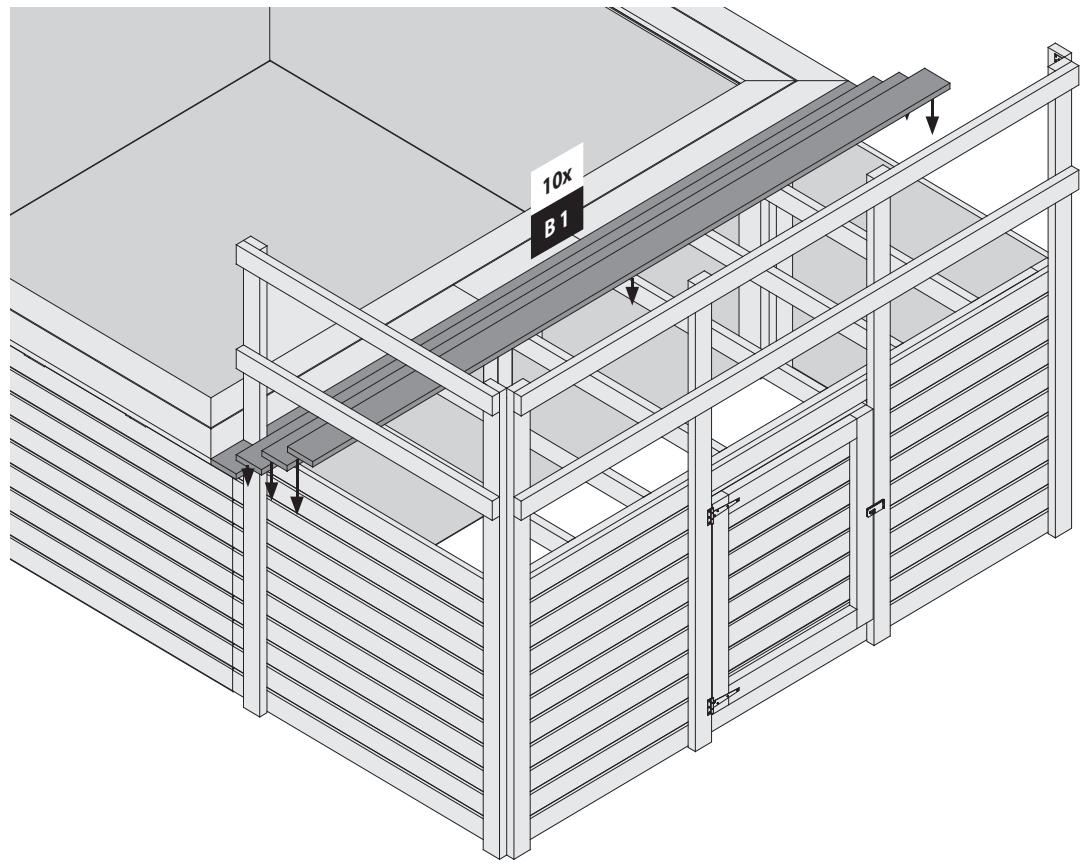
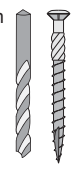

-  Bündig!
-  Flush!
-  Affleurement!
-  Gelijk!
-  I flugt!
-  Aras!
-  Combacia!
-  Stejný !

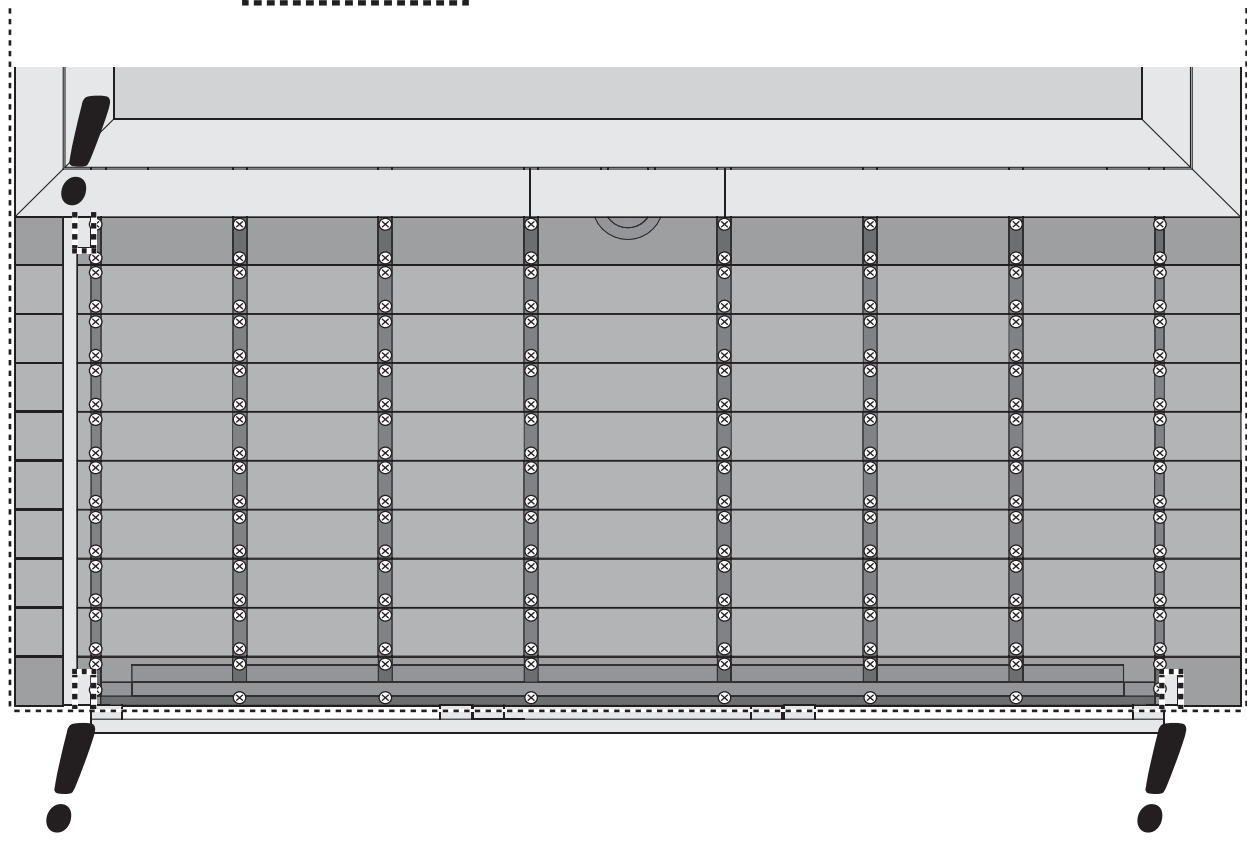
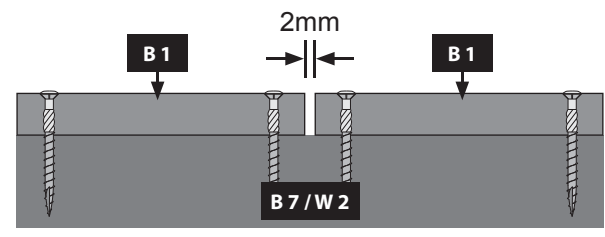

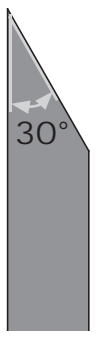
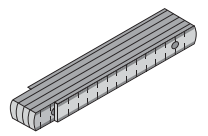
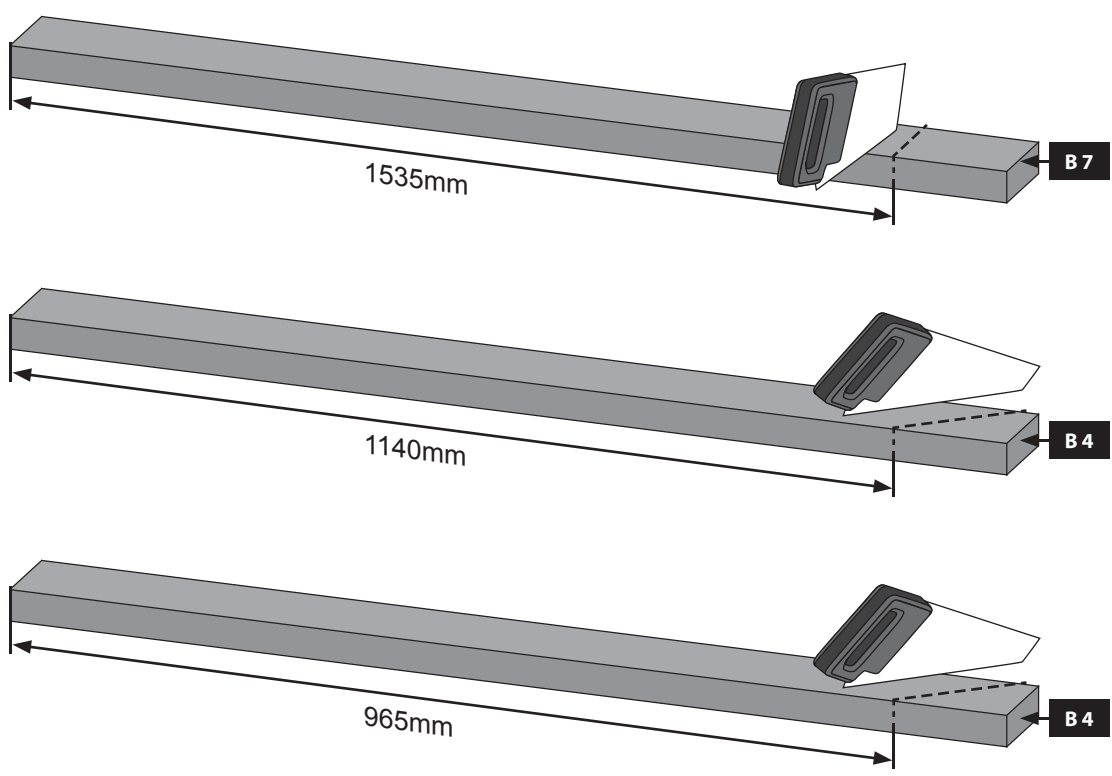

-  Bündig!
-  Flush!
-  Affleurement!
-  Gelijk!
-  I flugt!
-  Aras!
-  Combacia!
-  Stejný!

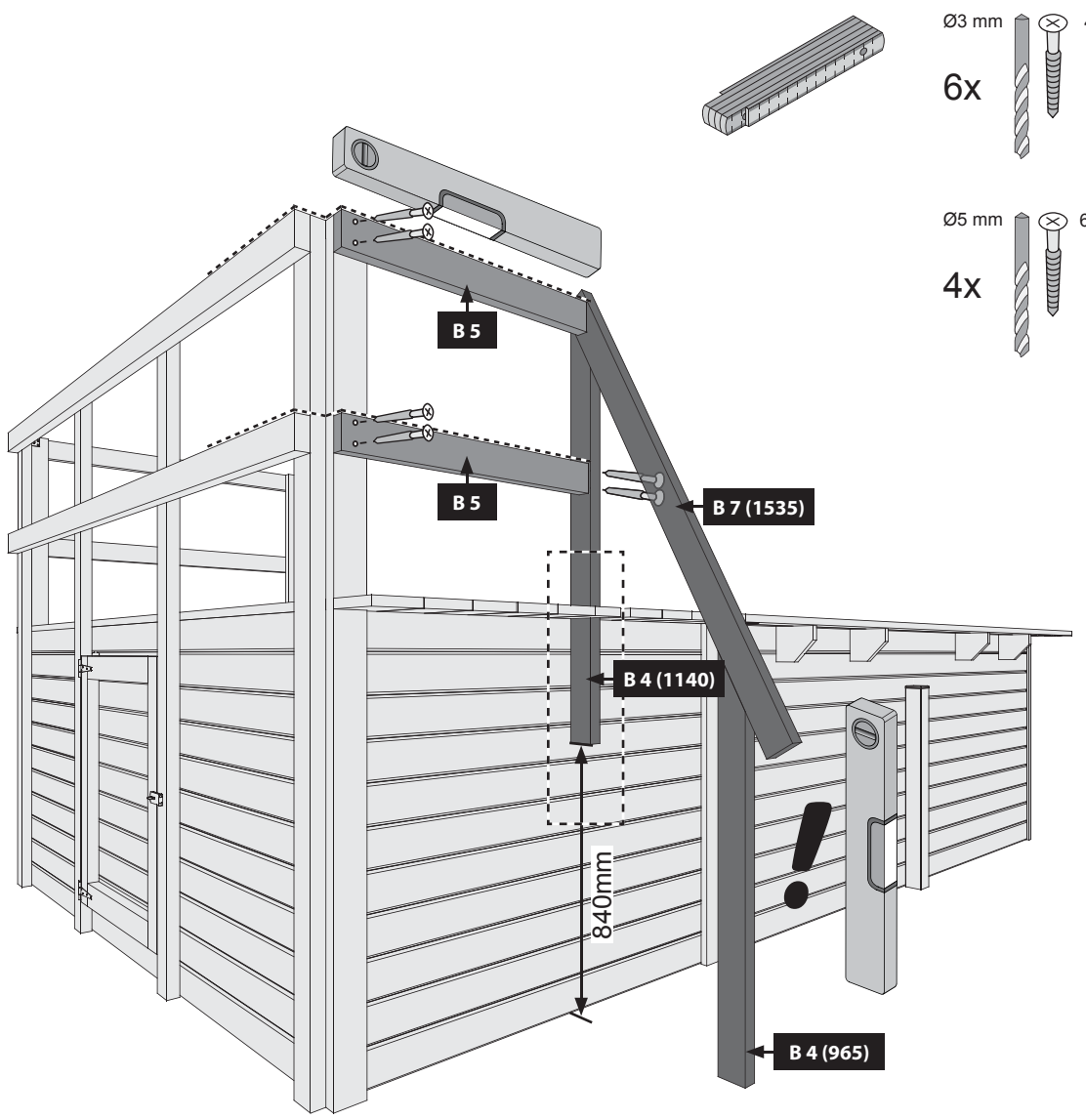

Ø3 mm 4x70

6x

Ø5 mm 6x100

4x

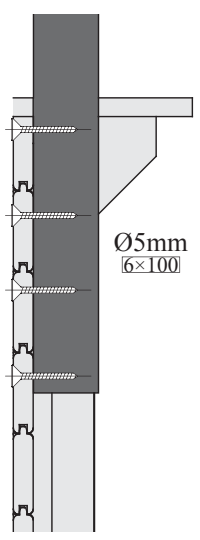

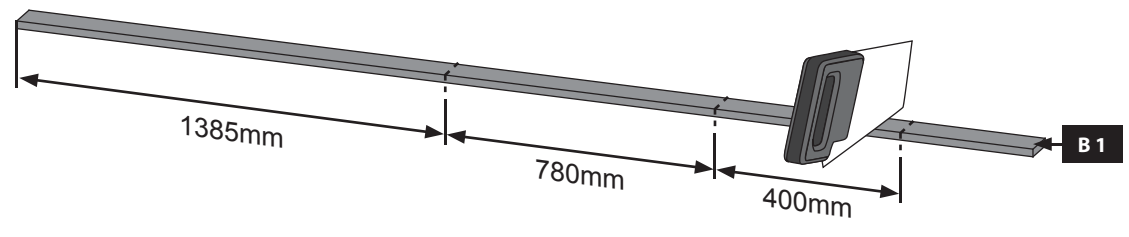
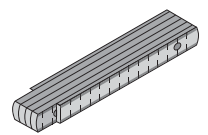
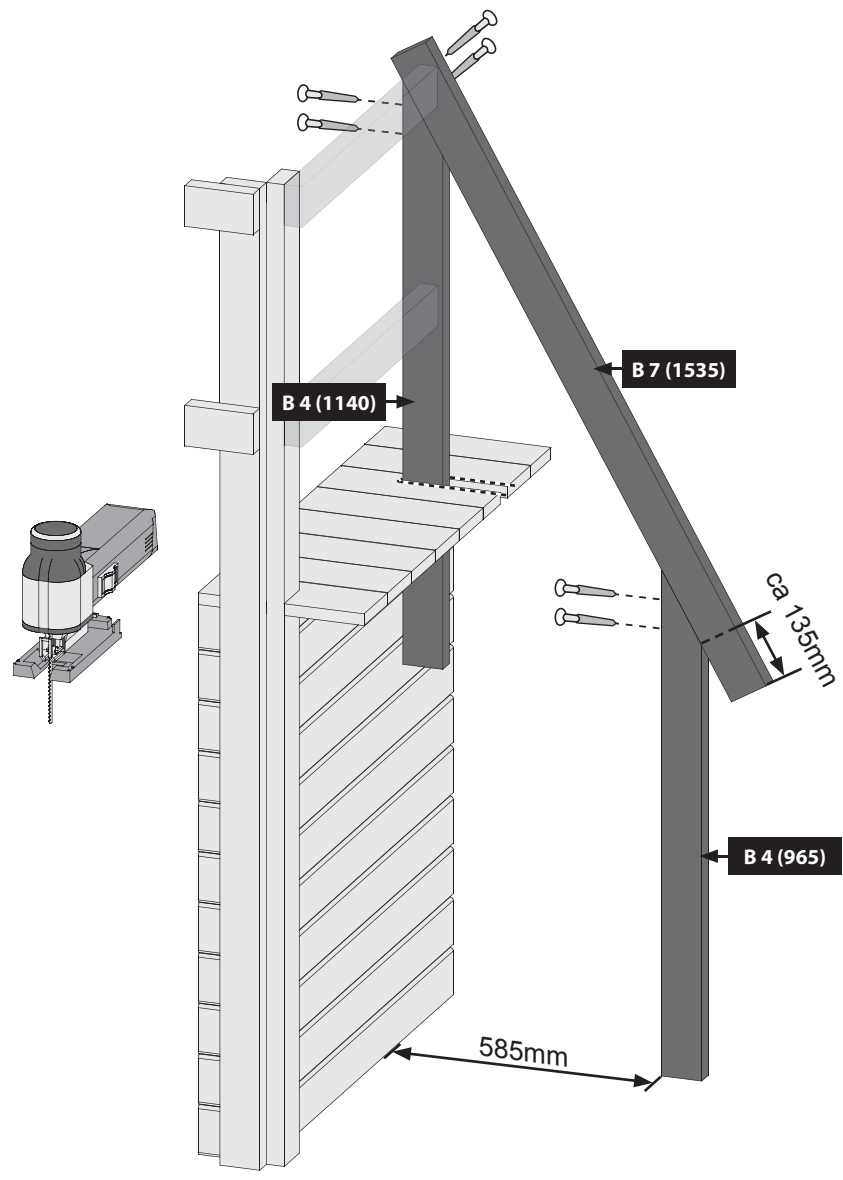
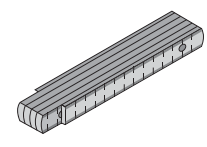
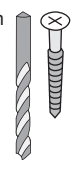

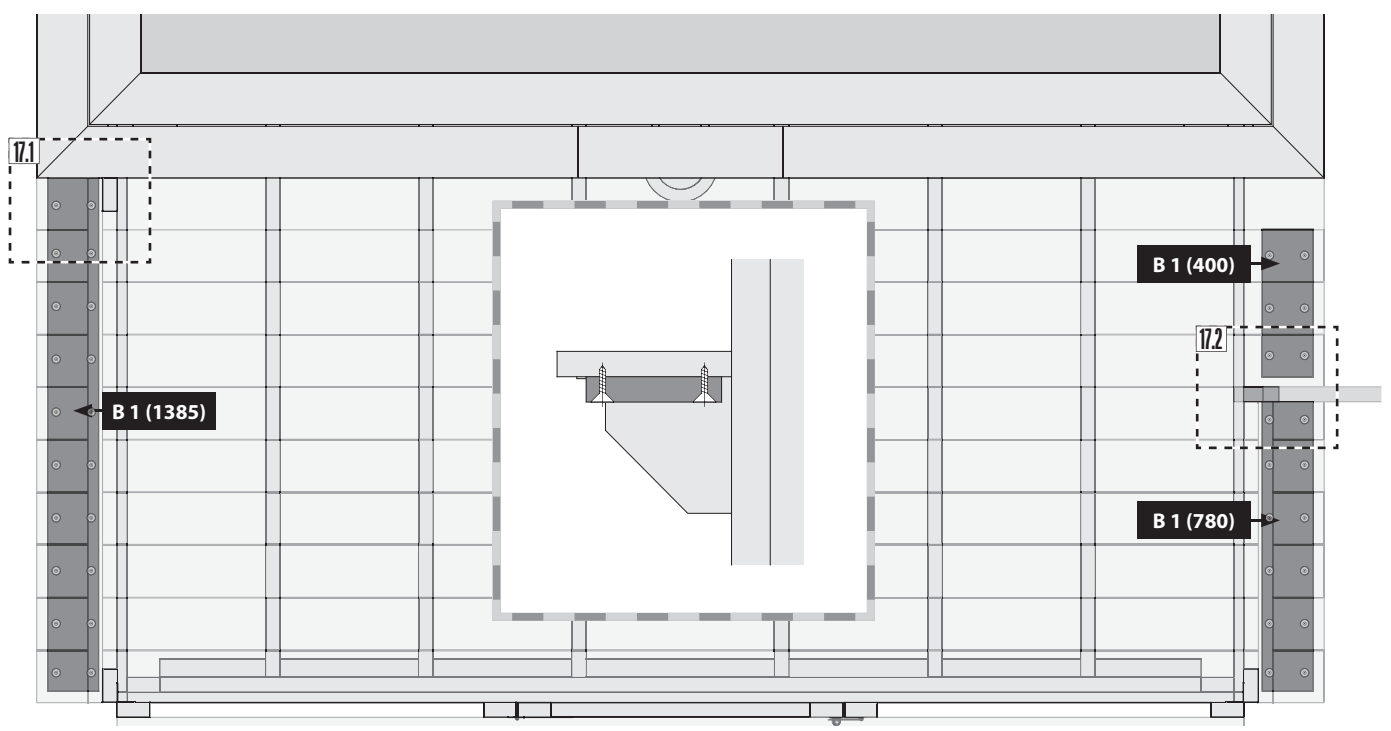
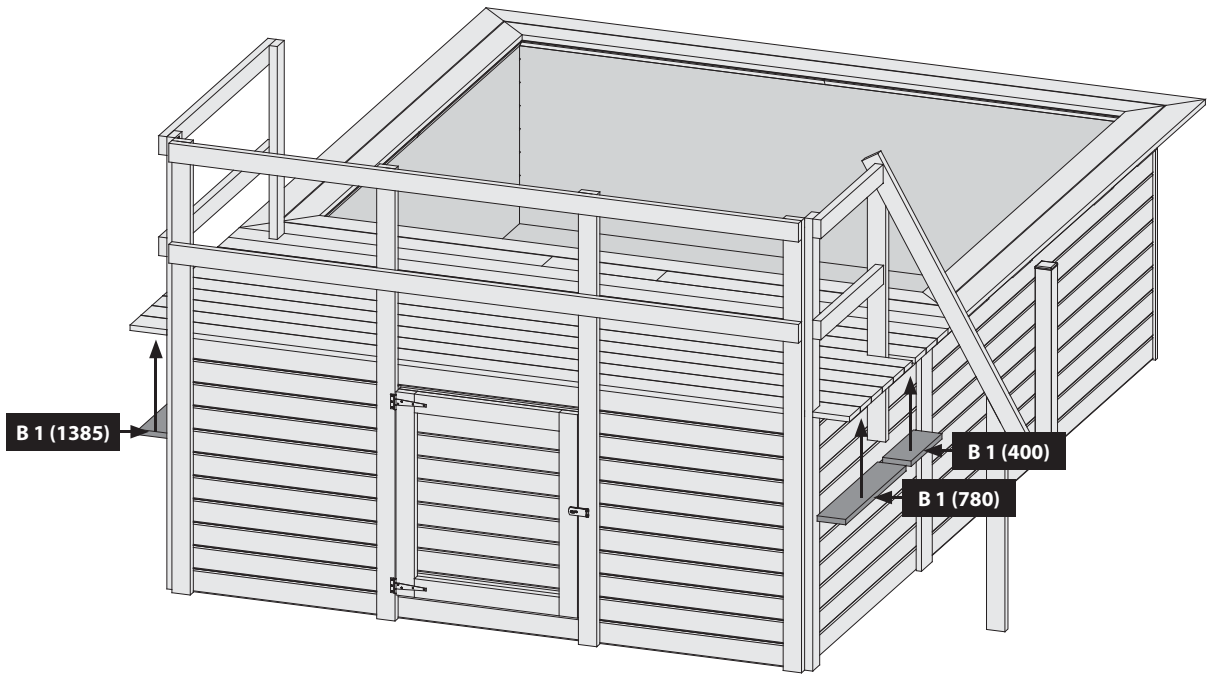
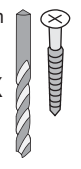

17.1

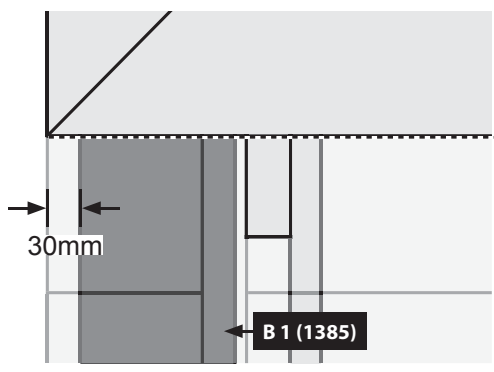

-  Bündig!
-  Flush!
-  Affleurement!
-  Gelijk!
-  I flugt!
-  Aras!
-  Combacia!
-  Stejný !

17.2

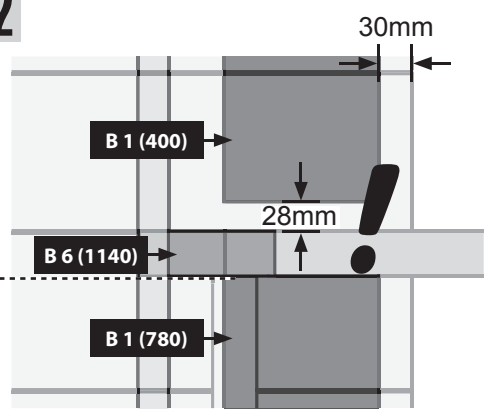

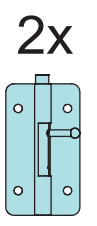
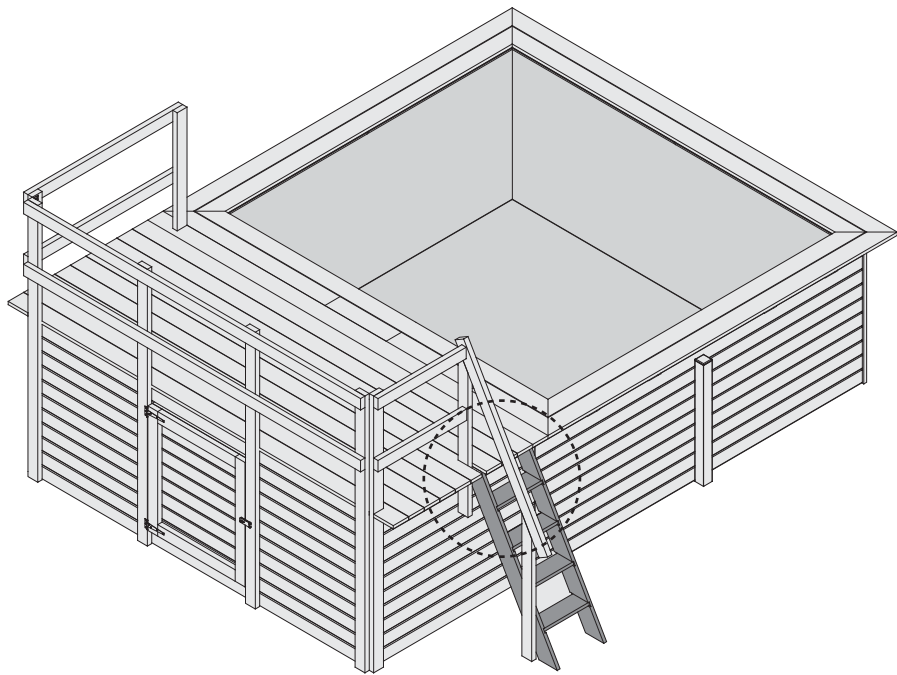

1.

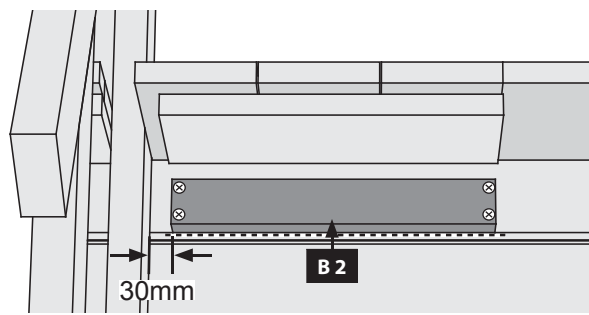

2.

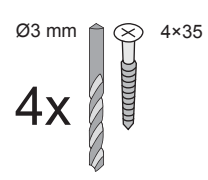
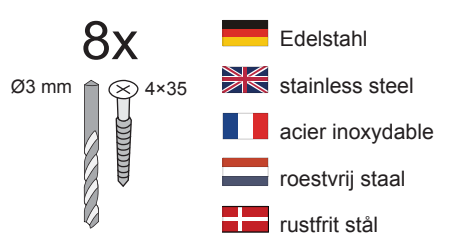
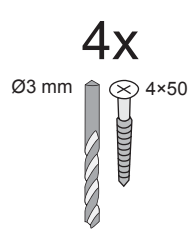
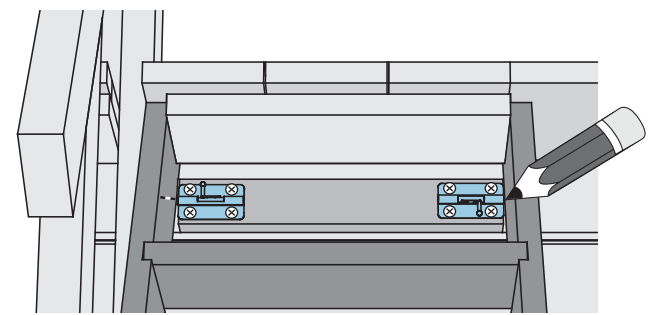

3.

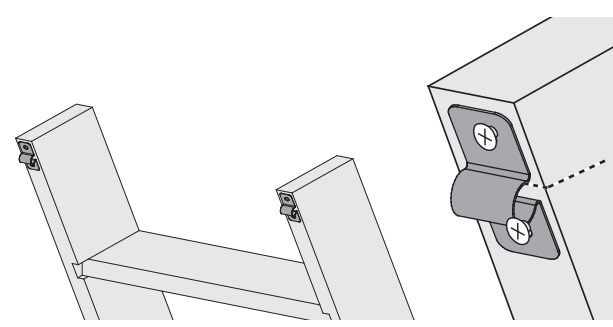

4.

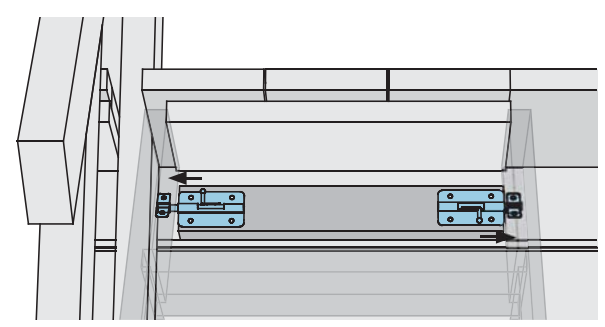

Ø8 mm 8x70
4x

